





MECHANICAL RESET FOR 3RU11/3RB20/3RB21
SIZE S00...S12







General technical data:

product brandname		SIRIUS
Product designation		mechanical RESET
Design of the product		resetting plunger, holder and funnel
Size of overload relay		S00, S0, S2, S3
Ambient temperature		
• during storage	°C	-50 ... +80
• during operation	°C	-20 ... +70

Certificates/ approvals:

General Product Approval	Declaration of Conformity	Test Certificates	Shipping Approval
 CSA	 UL	 EG-Konf.	Special Test Certificate Type Test Certificates/Test Report  ABS

Shipping Approval	other
 BUREAU VERITAS  LRS  RINA  RMRS	Environmental Confirmations Confirmation

Further information

Information- and Downloadcenter (Catalogs, Brochures,...)

<http://www.siemens.com/industrial-controls/catalogs>

Industry Mall (Online ordering system)

<http://www.siemens.com/industrymall>

Cax online generator

<http://support.automation.siemens.com/WW/CAXorder/default.aspx?lang=en&mlfb=3RU1900-1A>

Service&Support (Manuals, Certificates, Characteristics, FAQs,...)

<https://support.industry.siemens.com/cs/ww/en/ps/3RU1900-1A>

Image database (product images, 2D dimension drawings, 3D models, device circuit diagrams, EPLAN macros, ...)

http://www.automation.siemens.com/bilddb/cax_de.aspx?mlfb=3RU1900-1A&lang=en

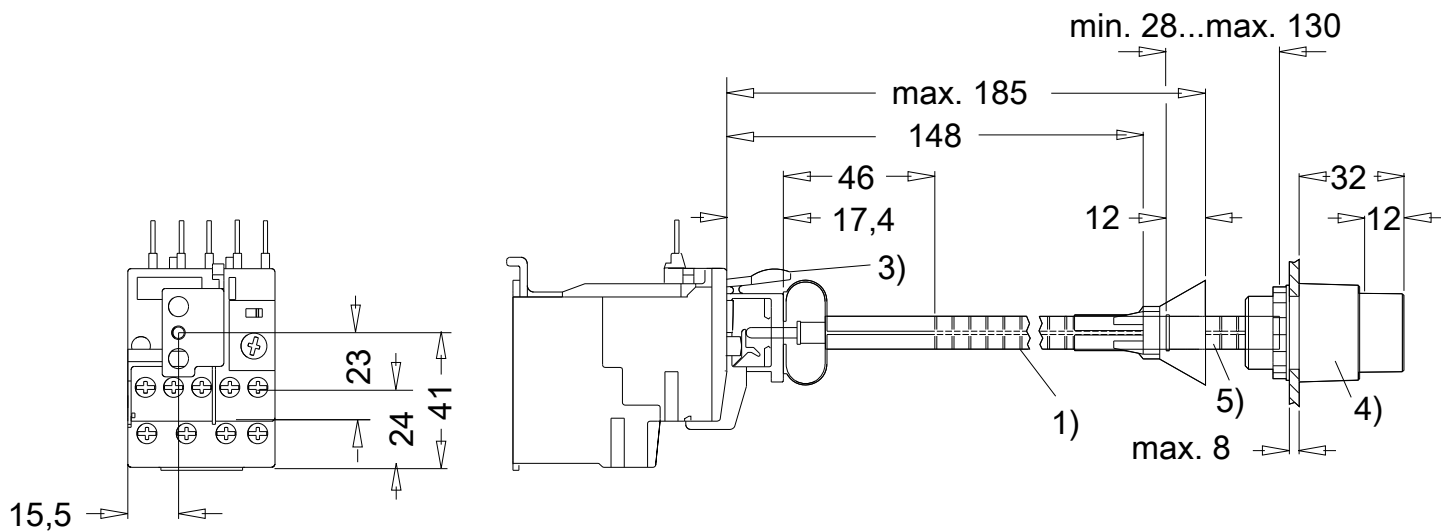

- 1) Wechsler für RESET
- 2) Dialer für RESET (400, 600 o 600 mm de largo, 400, 600 o 600 mm de altura)
- 3) Separador para RESET
- 4) Push button
- 5) Extensión de prolongación

last modified:

07/01/2017